

GRINDER PLATES

OUR PLATES ARE MADE OF HARDENED TOOL STEEL FOR LONGER LIFE

OTHER SIZE KNIVES AND PLATES ARE AVAILABLE UPON REQUEST

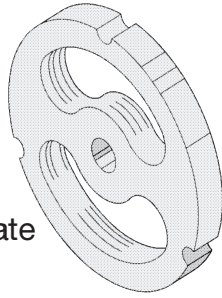

Kidney Plate

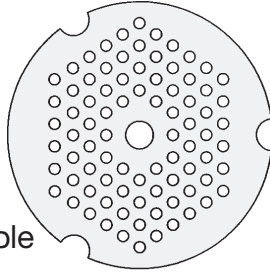

Reversible

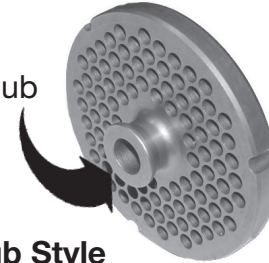
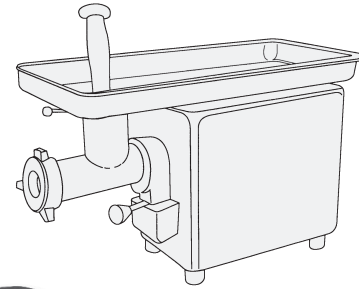

Hub

Hub Style
Non-Reversible

REVERSIBLE

| NBS P/N | Plate Size | Diameter | Hole Size |
|----------|------------|----------|-----------|
| GP12-18 | 12 (100) | 2 3/4 | 1/8 |
| GP12-316 | 12 (100) | 2 3/4 | 3/16 |
| GP12-14 | 12 (100) | 2 3/4 | 1/4 |
| GP12-38 | 12 (100) | 2 3/4 | 3/8 |
| GP12-12 | 12 (100) | 2 3/4 | 1/2 |
| GP12-34 | 12 (100) | 2 3/4 | 3/4 |
| GP12-K | 12 (100) | 2 3/4 | KIDNEY |

| NBS P/N | Plate Size | Diameter | Hole Size |
|----------|------------|----------|-----------|
| GP22-18 | 22 (200) | 3 1/4 | 1/8 |
| GP22-316 | 22 (200) | 3 1/4 | 3/16 |
| GP22-14 | 22 (200) | 3 1/4 | 1/4 |
| GP22-38 | 22 (200) | 3 1/4 | 3/8 |
| GP22-12 | 22 (200) | 3 1/4 | 1/2 |
| GP22-34 | 22 (200) | 3 1/4 | 3/4 |
| GP22-1 | 22 (200) | 3 1/4 | 1 |
| GP22-K | 22 (200) | 3 1/4 | KIDNEY |

| NBS P/N | Plate Size | Diameter | Hole Size |
|----------|------------|----------|-----------|
| GP32-18 | 32 (300) | 3 15/16 | 1/8 |
| GP32-316 | 32 (300) | 3 15/16 | 3/16 |
| GP32-14 | 32 (300) | 3 15/16 | 1/4 |
| GP32-38 | 32 (300) | 3 15/16 | 3/8 |
| GP32-12 | 32 (300) | 3 15/16 | 1/2 |
| GP32-34 | 32 (300) | 3 15/16 | 3/4 |
| GP32-1 | 32 (300) | 3 15/16 | 1 |
| GP32-K | 32 (300) | 3 15/16 | KIDNEY |

| NBS P/N | Plate Size | Diameter | Hole Size |
|----------|------------|----------|-----------|
| GP52-18 | 52 (400) | 5 1/8 | 1/8 |
| GP52-316 | 52 (400) | 5 1/8 | 3/16 |
| GP52-14 | 52 (400) | 5 1/8 | 1/4 |
| GP52-38 | 52 (400) | 5 1/8 | 3/8 |
| GP52-12 | 52 (400) | 5 1/8 | 1/2 |
| GP52-34 | 52 (400) | 5 1/8 | 3/4 |
| GP52-1 | 52 (400) | 5 1/8 | 1 |
| GP52-K | 52 (400) | 5 1/8 | KIDNEY |

| NBS P/N | Plate Size | Diameter | Hole Size |
|---------|------------|----------|-----------|
| GP56-18 | 56 (500) | 6 | 1/8 |
| GP56-12 | 56 (500) | 6 | 1/2 |

HUB STYLE -NON-REVERSIBLE

| NBS P/N | Plate Size | Diameter | Hole Size |
|-----------|------------|----------|-----------|
| GPH32-18 | 32 (300) | 3 15/16 | 1/8 |
| GPH32-316 | 32 (300) | 3 15/16 | 3/16 |
| GPH32-14 | 32 (300) | 3 15/16 | 1/4 |
| GPH32-38 | 32 (300) | 3 15/16 | 3/8 |
| GPH32-34 | 32 (300) | 3 15/16 | 3/4 |
| GPH32-1 | 32 (300) | 3 15/16 | 1 |

| NBS P/N | Plate Size | Diameter | Hole Size |
|-----------|------------|----------|-----------|
| GPH52-18 | 52 (400) | 5 1/8 | 1/8 |
| GPH52-316 | 52 (400) | 5 1/8 | 3/16 |
| GPH52-14 | 52 (400) | 5 1/8 | 1/4 |
| GPH52-38 | 52 (400) | 5 1/8 | 3/8 |

HOLE SIZE RECOMMENDATIONS

| HOLE SIZE | TYPICAL PRODUCT |
|-----------|------------------|
| 1/8" | Hamburger |
| 3/16" | Regular Sausage |
| 1/4" | Regular Chili |
| 1/2" | Coarse Chili |
| 5/8" | 1st Grind |
| 3/4" | 1st Grind Chili |
| Kidney | 1st Grind Chunks |

The above described parts are supplied by National Band Saw Company as replacement parts.



GRINDER PLATES

OUR PLATES ARE MADE OF HARDENED TOOL STEEL FOR LONGER LIFE

OTHER SIZE KNIVES AND PLATES ARE AVAILABLE UPON REQUEST

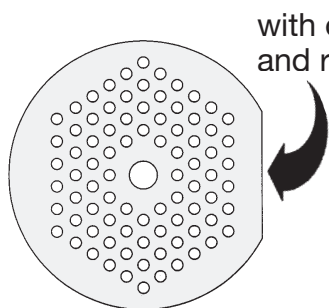

1 FLAT EDGE AND REVERSIBLE

| NBS P/N | Plate Size | Diameter | Hole Size |
|-----------|------------|----------|-----------|
| GPF12-18 | 12 (100) | 2 3/4 | 1/8 |
| GPF12-316 | 12 (100) | 2 3/4 | 3/16 |
| GPF12-14 | 12 (100) | 2 3/4 | 1/4 |
| GPF12-38 | 12 (100) | 2 3/4 | 3/8 |
| GPF12-12 | 12 (100) | 2 3/4 | 1/2 |
| GPF12-34 | 12 (100) | 2 3/4 | 3/4 |
| GPF12-K | 12 (100) | 2 3/4 | KIDNEY |

| NBS P/N | Plate Size | Diameter | Hole Size |
|-----------|------------|----------|-----------|
| GPF22-18 | 22 (200) | 3 1/4 | 1/8 |
| GPF22-316 | 22 (200) | 3 1/4 | 3/16 |
| GPF22-14 | 22 (200) | 3 1/4 | 1/4 |
| GPF22-38 | 22 (200) | 3 1/4 | 3/8 |
| GPF22-12 | 22 (200) | 3 1/4 | 1/2 |
| GPF22-34 | 22 (200) | 3 1/4 | 3/4 |
| GPF22-K | 22 (200) | 3 1/4 | KIDNEY |

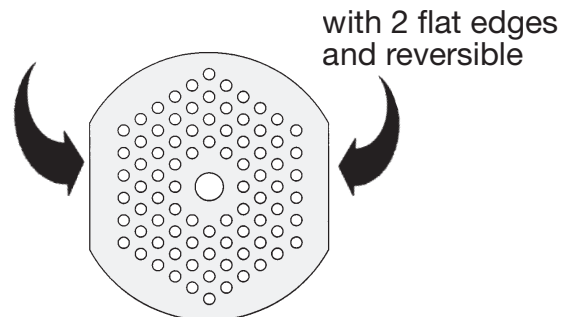

2 FLAT EDGES AND REVERSIBLE

| NBS P/N | Plate Size | Diameter | Hole Size |
|-------------|------------|----------|-----------|
| GP12-2F-18 | 12 (100) | 2 3/4 | 1/8 |
| GP12-2F-316 | 12 (100) | 2 3/4 | 3/16 |
| GP12-2F-14 | 12 (100) | 2 3/4 | 1/4 |
| GP12-2F-38 | 12 (100) | 2 3/4 | 3/8 |
| GP12-2F-12 | 12 (100) | 2 3/4 | 1/2 |
| GP12-2F-34 | 12 (100) | 2 3/4 | 3/4 |
| GP12-2F-K | 12 (100) | 2 3/4 | KIDNEY |

| NBS P/N | Plate Size | Diameter | Hole Size |
|-------------|------------|----------|-----------|
| GP22-2F-18 | 22 (200) | 3 1/4 | 1/8 |
| GP22-2F-316 | 22 (200) | 3 1/4 | 3/16 |
| GP22-2F-14 | 22 (200) | 3 1/4 | 1/4 |
| GP22-2F-38 | 22 (200) | 3 1/4 | 3/8 |
| GP22-2F-12 | 22 (200) | 3 1/4 | 1/2 |
| GP22-2F-34 | 22 (200) | 3 1/4 | 3/4 |
| GP22-2F-K | 22 (200) | 3 1/4 | KIDNEY |

| NBS P/N | Plate Size | Diameter | Hole Size |
|-------------|------------|----------|-----------|
| GP32-2F-18 | 32 (300) | 3 15/16 | 1/8 |
| GP32-2F-316 | 32 (300) | 3 15/16 | 3/16 |
| GP32-2F-14 | 32 (300) | 3 15/16 | 1/4 |
| GP32-2F-38 | 32 (300) | 3 15/16 | 3/8 |
| GP32-2F-12 | 32 (300) | 3 15/16 | 1/2 |
| GP32-2F-34 | 32 (300) | 3 15/16 | 3/4 |
| GP32-2F-1 | 32 (300) | 3 15/16 | 1 |
| GP32-2F-K | 32 (300) | 3 15/16 | KIDNEY |

| NBS P/N | Plate Size | Diameter | Hole Size |
|-------------|------------|----------|-----------|
| GP52-2F-18 | 52 (400) | 5 1/8 | 1/8 |
| GP52-2F-316 | 52 (400) | 5 1/8 | 3/16 |
| GP52-2F-14 | 52 (400) | 5 1/8 | 1/4 |
| GP52-2F-38 | 52 (400) | 5 1/8 | 3/8 |
| GP52-2F-12 | 52 (400) | 5 1/8 | 1/2 |
| GP52-2F-34 | 52 (400) | 5 1/8 | 3/4 |
| GP52-2F-1 | 52 (400) | 5 1/8 | 1 |
| GP52-2F-K | 52 (400) | 5 1/8 | KIDNEY |

Most Knives will have a square drive, plates are offered in hub or flat reversible. Most plates will have notch on the outside diameter to prevent the plate from spinning. Some older designs have one-sided flat or two-sided flat.

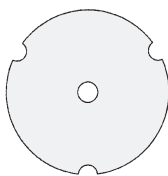

Hobart / Biro Styles- 3 Notches

#32 & #52 size have 3 notches. Smaller sizes typically have 1 notch.



Butcher Boy Style- One Flat

Some grinder heads have a recess where the plate nests.

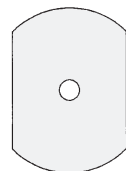

Butcher Boy Style- Two Flats

This plate will work with heads with 1 or 3 pins.

IMPORTANT... USE KNIFE AND PLATE TOGETHER AS A MATCHED SET
Always use the same knife and plate together. If one has gradually worn away from perfect flat, the other will have worn with it. As a result they may still be used together. However, if one is matched with a different item which is ground true, the set will certainly not turn out a good product. In addition, such practice will probably break the new item.

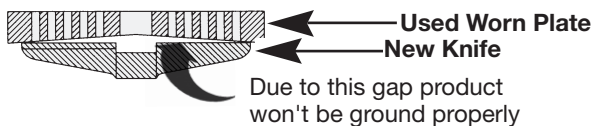

CHOPPER-GRINDERS



GRINDER KNIVES

OTHER SIZE KNIVES AND PLATES
ARE AVAILABLE UPON REQUEST

**HARDENED STEEL INSERTS
BRAZED TO LENGTHEN LIFE OF KNIFE**

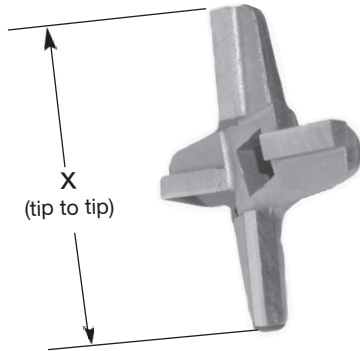

HT123
Safety Glove
Cloth w/ Steel Wire
This glove is ambidextrous...
fits right or left hand

**THESE KNIVES ARE ONE PIECE
FORGED STEEL AND HARDENED**

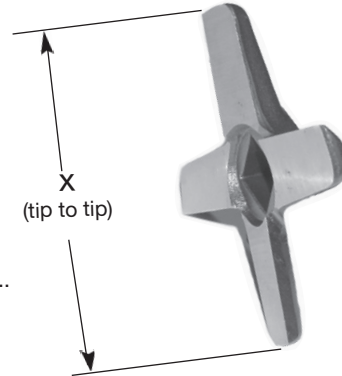

| NBS P/N | Fits | X (tip to tip) | Square Hole |
|---------|----------|----------------|-------------|
| GK12-S | 12 (100) | 2 1/2 | .468 |
| GK22-S | 22 (200) | 2 7/8 | .520 |
| GK32-S | 32 (300) | 3 1/2 | .578 |
| GK52-S | 52 (400) | 4 1/2 | .860 |
| GK56-S | 56 (500) | 5 1/4 | .860 |

| NBS P/N | Fits | X (tip to tip) |
|---------|----------|----------------|
| GK12-F | 12 (100) | 2 1/2 |
| GK22-F | 22 (200) | 2 7/8 |
| GK32-F | 32 (300) | 3 1/2 |
| GK52-F | 52 (400) | 4 1/2 |

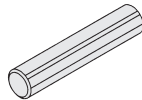

Biro Grinder Plate Pins

FITS MODELS

| NBS P/N | OEM P/N | DESCRIPTION | FITS PLATE | PIN DIAMETER | 342 | 346 | 548 | 722 | 812 | 822 | 922 | 6642 | 7552 | AFMG48 |
|---------|---------|-------------|------------|--------------|-----|-----|-----|-----|-----|-----|-----|------|------|--------|
| GR16 | CP12 | Grinder Pin | 12 | 5/32 | | | | | X | | | | | |
| GR17 | CP22 | Grinder Pin | 22 | 3/16 | | | | X | | X | X | | | |
| GR18 | HP48 | Grinder Pin | 32 | 7/32 | X | X | X | | | | | X | | X |
| GR19 | HP52 | Grinder Pin | 52 | 9/32 | | | | | | | | | X | |

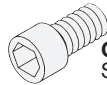
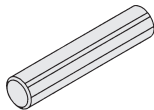

GR21
Special Screw

Butcher Boy Grinder Plate Pins

FITS MODELS

| NBS P/N | OEM P/N | DESCRIPTION | FITS PLATE | PIN DIAMETER | TCA12 | TCA22 | TCA32 | 100/42 | 100/52 | 200/42 | 200/52 | A42 | A52 | A56 |
|---------|----------|---------------|------------|--------------|-------|-------|-------|--------|--------|--------|--------|-----|-----|-----|
| GR14 | DP-04-12 | Grinder Pin | 12, 22 | 1/4 | X | X | | | | | | | | |
| GR15 | DP-06-24 | Grinder Pin | 56 | 3/8 | | | | | | | | | | X |
| GR20 | DP-05-24 | Grinder Pin | 52 | 5/16 | | | | | X | | X | | X | |
| GR21 | 59232 | Special Screw | 32 | | | | X | X | | X | | X | | |

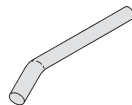

Hobart Grinder Plate Pins

FITS MODELS

| NBS P/N | OEM P/N | DESCRIPTION | FITS PLATE | PIN DIAMETER | 1532 | 4146 | 4152 | 4246 | 4346 | 4612 | 4632 | 4732 | 4812 | 4822 |
|---------|---------|-------------|------------|--------------|------|------|------|------|------|------|------|------|------|------|
| GR10 | 122999 | Grinder Pin | 12 | 5/32 | | | | | | X | | | X | |
| GR11 | 122983 | Grinder Pin | 22 | 3/16 | | | | | | | | | | X |
| GR12 | 105806 | Grinder Pin | 32 | 7/32 | X | X | | X | X | | X | X | | |
| GR13 | 102130 | Grinder Pin | 52 | 1/4 | | | X | | | | | | | |

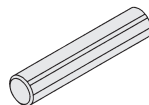

Hollymatic Grinder Plate Pins

FITS MODELS

| NBS P/N | OEM P/N | DESCRIPTION | FITS PLATE | PIN DIAMETER | 100/42 | 100/52 | 175/42 | 175/52 | 180/42 | 180/52 |
|---------|------------|-------------|------------|--------------|--------|--------|--------|--------|--------|--------|
| GR18 | 1000204 | Grinder Pin | 32 | 7/32 | X | | X | | X | |
| GR20 | 7651420900 | Grinder Pin | 52 | 5/16 | | X | | X | | X |

The above described parts are supplied by **National Band Saw Company** as replacement parts.



CHOPPER KNIFE & PLATE CROSS REFERENCE

| MAKE & MODEL | PLATE SIZE | | | |
|-----------------------------------|------------|----|----|----|
| | 12 | 22 | 32 | 52 |
| AMERICAN | | | | |
| 6212 | X | | | |
| U.S. BERKEL | | | | |
| E-012 | X | | | |
| E-122, E-222 | | X | | |
| E-2732 | | | X | |
| BIRO | | | | |
| 8-12 | X | | | |
| 22, 8-22, 9-22 | | X | | |
| 342, 346, 548, 6642 | | | X | |
| 7542, 7548, AFMG-48-2 | | | X | |
| 542, 7500 | | | X | |
| 552, 7552 | | | | X |
| BLAKESLEE | | | | |
| CC20S | X | | | |
| BUFFALO | | | | |
| 41B | | X | | |
| 51B | | | | X |
| BUTCHER BOY | | | | |
| TCA12, TM12 | X | | | |
| TCA22, TM22 | | X | | |
| TCA32, TM32 / 232, A42 | | | X | |
| A52, AU52, B52, B52HB | | | | X |
| CHOP RITE | | | | |
| 210 | X | | | |
| 310 | | X | | |
| 510 | | | X | |
| ENTERPRISE | | | | |
| 10, 2112, 2512, 2612, 2712 | X | | | |
| 422, 2522, 2622, 2722 | | X | | |
| 30, 41, 432, 1041, 1541, 2532 | | | X | |
| 341, 2632, 2732, 2742, 2746, 2842 | | | X | |
| FLEETWOOD | | | | |
| M12S | X | | | |
| M32S | | | X | |
| GENERAL SLICING | | | | |
| D, H, P, MC-50 | X | | | |
| E, MC-100 | | X | | |

| MAKE & MODEL | PLATE SIZE | | | |
|--|------------|----|----|----|
| | 12 | 22 | 32 | 52 |
| GLOBE - STIMPSON | | | | |
| 5412, 5511 | X | | | |
| 422S, 2522, 5522, 5622, 5822, 6722 | | X | | |
| 842D, 3028, 5932, 6142, 6832, 6942, 8142 | | | X | |
| HOBART | | | | |
| 56, 200, 212, 612, 725 | X | | | |
| 4212, 4312, 4412, 4612, 4812, 5113, F230 | X | | | |
| 622, 4222, 4322, 4722, 4822 | | X | | |
| 4046, 4145, 4146, 4241, 4245, 4246 | | | X | |
| 4322, 4332, 4342, 4346, 4531 | | | X | |
| 4532, 4542, 4632, 4732, 5425, MC-46 | | | X | |
| HOLLYMATIC | | | | |
| 1000 | X | | | |
| 22S, 1200 | | X | | |
| 2-32S, 32S, 150, 175, 542, 1332, GEMINI | | | X | |
| INTEDGE | | | | |
| C2HA, C2HDS, C3H, CSH | X | | | |
| C1H, C1HDS | | X | | |
| JUPITER | | | | |
| B63 | X | | | |
| KREFFT | | | | |
| R-70 | X | | | |
| SANITARY | | | | |
| 100,101, 600, 900, S612 | X | | | |
| 200, 201,1250,1275 | | X | | |
| 2800, 3800, 4000 | | | X | |
| THUNDERBIRD | | | | |
| TB300E, TX600 | X | | | |
| TOLEDO | | | | |
| 5120 | X | | | |
| 5220 | | X | | |
| 5223 | | X | | |
| TORREY | | | | |
| M-12 | X | | | |
| M-22 | | X | | |
| M-32 | | | X | |
| UNIVEX | | | | |
| MG8912 | X | | | |

