

FITS HI-YIELD 16

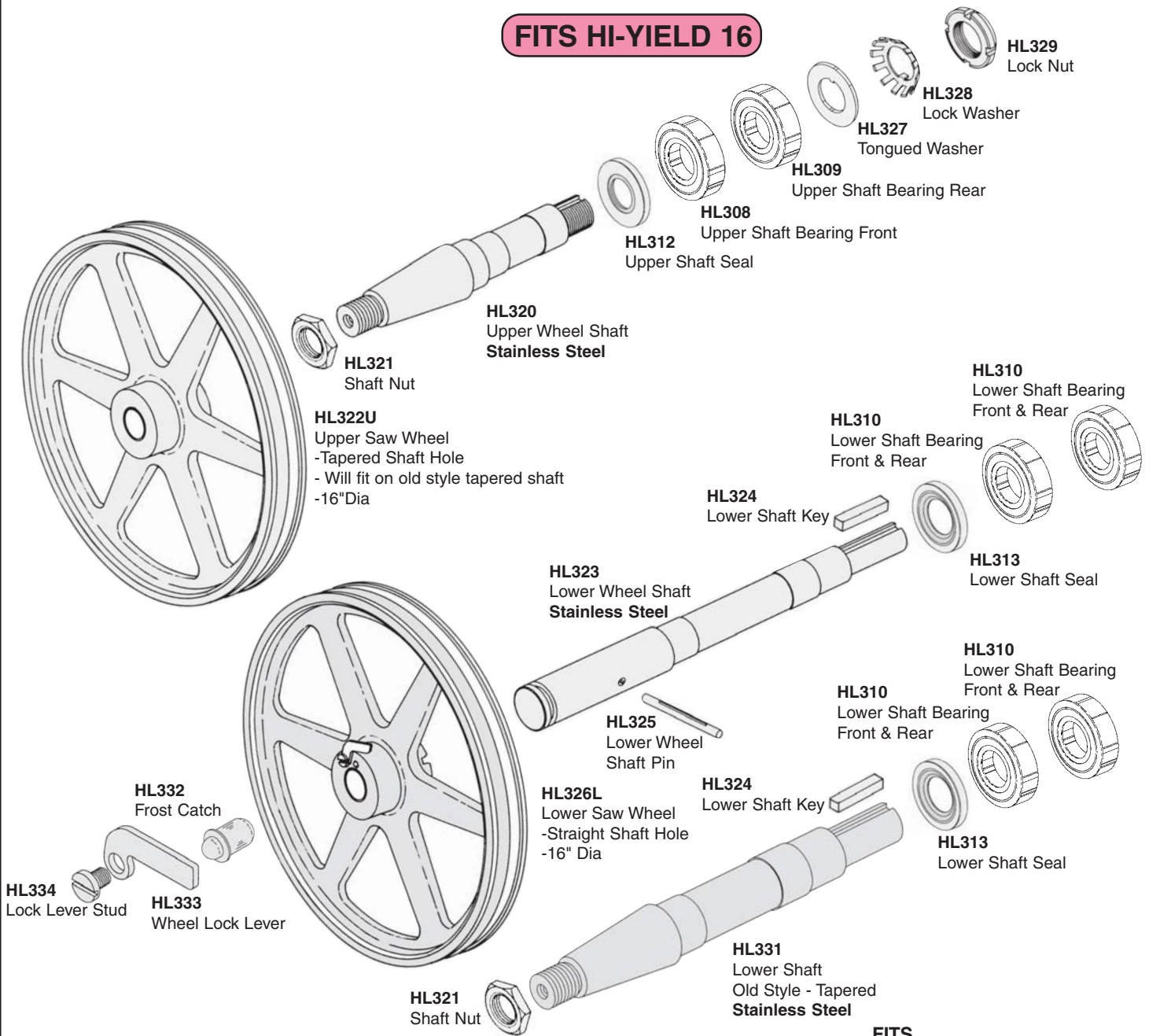

FITS

NBS P/N	OEM P/N	DESCRIPTION	HI-YIELD 16
HL308	680-2032	Upper Shaft Bearing-Front	X
HL309	680-2034	Upper Shaft Bearing-Rear	X
HL310	680-2036	Lower Shaft Bearing-Front & Rear	X
HL312	680-2031	Upper Shaft Seal	X
HL313	680-1110	Lower Shaft Seal	X
HL320	680-1116	Upper Wheel Shaft	X
HL321	74000-8240	Shaft Nut	X
HL322U	680-1163	Upper Saw Wheel -Tapered Shaft Hole	X
HL323	680-2203	Lower Wheel Shaft	X
HL324	480-0630	Lower Shaft Key	X
HL325	680-1159	Lower Wheel Shaft Pin	X
HL326L	680-1165	Lower Saw Wheel -Straight Shaft Hole	X
HL327	680-1321	Tongued Washer	X
HL328	680-1224	Lock Washer	X
HL329	680-1223	Lock Nut	X
HL331	680-2025	Lower Shaft Old Style	X
HL332	680-2218	Frost Catch	X
HL333	680-2204	Wheel Lock Lever	X
HL334	680-2214	Lock Lever Stud	X

The above described parts are supplied by **National Band Saw Company** as replacement parts for **Hollymatic** equipment.

HOLLMATIC SAW



FITS HI-YIELD 16

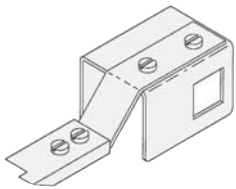

HL315
Wheel Scraper Bracket Assy -
Stainless Steel

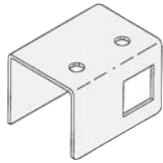

HL314
Wheel Scraper Bracket -
Stainless Steel

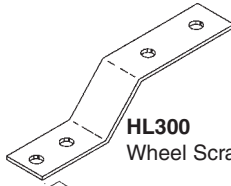

HL300
Wheel Scraper Spring

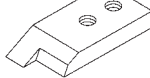

HL301
Wheel Scraper
- Fiber

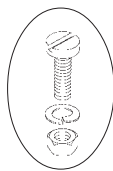

HL303
Screws, Washers & Nuts
Stainless Steel
(4/pkg)

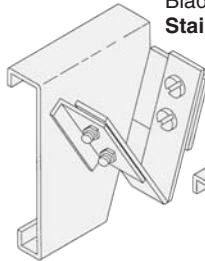

HL317
Blade Scraper Bracket Assy-
Stainless Steel

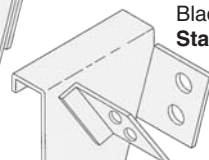

HL316
Blade Scraper Bracket -
Stainless Steel



HL304
Blade Scraper

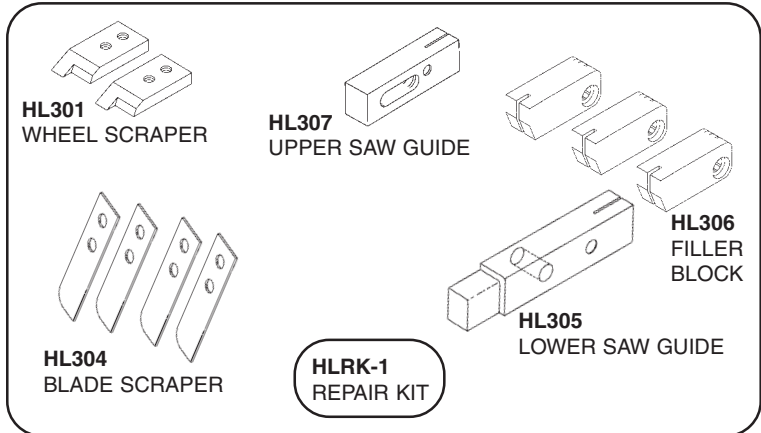

HL307
Upper Saw Guide

HL335
Upper Saw Guide
Stainless Steel

HL306
Filler Block
- Nylon

HL305
Lower Saw Guide
1/4-28 Thread O/S

HL336
Lower Saw Guide
1/4-28 Thread O/S
Stainless Steel

FITS

NBS P/N	OEM P/N	DESCRIPTION	HI-YIELD 16
HLRK-1	N/A	Repair Kit	X
HL300	680-1155	Wheel Scraper Spring	X
HL301	680-1156	Wheel Scraper - Fiber	X
HL303	713031640	Screws, Washers & Nuts <i>Stainless Steel</i> (4/pkg)	X
HL304	680-1067	Blade Scraper	X
HL305	680-2027	Lower Saw Guide	X
HL306	680-1081	Filler Block - Nylon	X
HL307	680-1041	Upper Saw Guide	X
HL314	680-2081	Wheel Scraper Bracket - <i>Stainless Steel</i>	X
HL315	680-2088	Wheel Scraper Bracket - <i>Assembly</i>	X
HL316	680-2126	Blade Scraper Bracket - <i>Stainless Steel</i>	X
HL317	680-2125	Blade Scraper Bracket - <i>Assembly</i>	X
HL335	680-1041	Upper Saw Guide - <i>Stainless Steel</i>	X
HL336	680-2027	Lower Saw Guide - <i>Stainless Steel</i>	X

The above described parts are supplied by **National Band Saw Company** as replacement parts for **Hollymatic** equipment.



FITS HI-YIELD 16

**ALL NEW
FOR 2007**

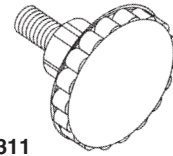

NEW



NEW



NEW

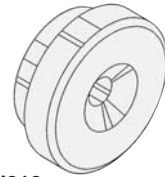
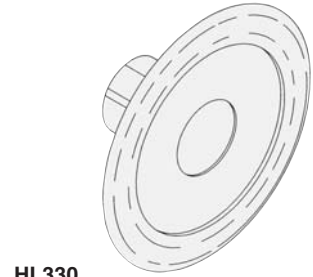

			FITS
NBS P/N	OEM P/N	DESCRIPTION	HI-YIELD 16
HL311	680-2017	Guide Rod Lock Knob	X
HL318	6802148	Table Roller	X
HL330	680-1379	On-Off Push Knob Red	X
HL337	680-1082	Toggle Plate	X
HL338	680-1083	Ball Knob	X
HL339	680-1084	Plunger	X
HL340	580-5018	Large Spring	X
HL341	580-5019	Small Spring	X

The above described parts are supplied by **National Band Saw Company** as replacement parts for **Hollymatic** equipment.

