

FITS MODELS

NBS P/N	OEM P/N	DESCRIPTION	SE8	SG8D
BZ005	40220402000	Small Clamping Handle (Stainless)	X	X
BZ009	60350402200	Gripping Clamp (Stainless)	X	X
BZ010	56972770000	Gripping Clamp Bolt (Stainless-Metric)	X	X
BZ011		Gripping Clamp Nut (Stainless-Metric)	X	X
BZ012	56739060000	Gripping Clamp Washer (Stainless)	X	X
BZ013		Gripping Clamp Cap	X	X
BZ014	60140104600	Sliding Bolt (plastic wear pad)	X	X
BZ015	50001170000	Bushing	X	X
BZ018	60350401500	Guide Shaft	X	X
BZ019	56972770000	Knife Shaft Screw (1 Short & 1 Long)	X	X
BZ020	60350404100	Remnant Holder w/Mounting Hardware & Knob	X	X
BZ030	60351200000	Swivel Guide Bar & Knob	X	X
BZ031	N/A	Knob w/Set Screw	X	X
BZ032	N/A	Remnant Holder Threaded Stud	X	X
BZ033	N/A	Remnant Holder Screw	X	X
BZ034	N/A	Remnant Holder Nut	X	X
BZ038	60350402800	Threaded Stud	X	X

The above described parts are supplied by **National Band Saw Company** as replacement parts for **Bizerba** equipment.

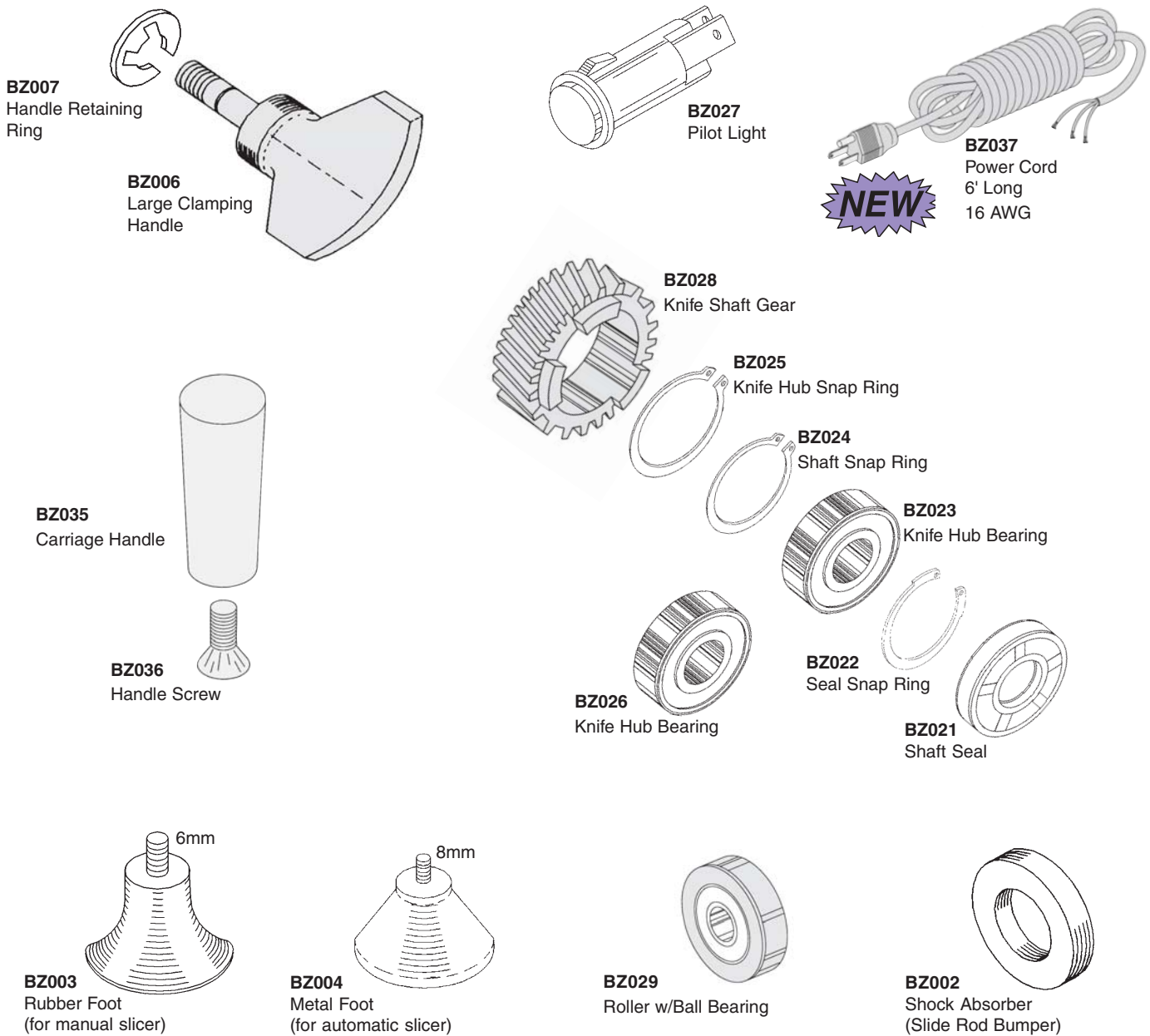



FITS MODELS

NBS P/N	OEM P/N	DESCRIPTION	355	A330	SE8	SE12	SG8D
BZ002	60220102800	Shock Absorber (Slide Rod Bumper)			X		X
BZ003	60610000124	Rubber Foot (for manual slicer)			X	X	
BZ004	60360304900	Metal Foot (for automatic slicer)		X			X
BZ006	40220400600	Large Clamping Handle			X		X
BZ007	57753800000	Handle Retaining Ring			X		X
BZ021	50000940000	Shaft Seal		X			
BZ022	57778820000	Seal Snap Ring	X	X			
BZ023	56362910000	Knife Hub Bearing	X	X			
BZ024	57778650000	Shaft Snap Ring	X	X			
BZ025	57773340000	Knife Hub Snap Ring	X	X			
BZ026	56362850000	Knife Hub Bearing			X		X
BZ027	71123670000	Pilot Light		X	X		X
BZ028	60510100037	Knife Shaft Gear		X			
BZ029	00110101004	Roller w/Ball Bearing		X	X		X
BZ035	56086100000	Carriage Handle		X			
BZ036	57442720000	Handle Screw		X			
BZ037	N/A	Power Cord 6' Long	X	X	X	X	X

The above described parts are supplied by National Band Saw Company as replacement parts for Bizerba equipment.



# Sharpener Stones

**BZST-1**

Sharpener Stones

**NOTE:** Both grinding and truing stones are packaged in see-through plastic bags with a divider to protect the surfaces.

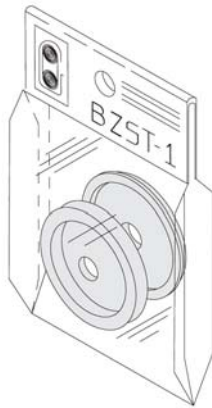

**NEW**

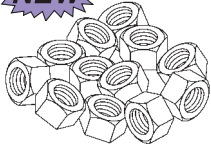

**BZ039**

Spindle Nuts  
Truing and Grinding Stones  
Left Hand (10/pkg)  
**Stainless Steel**

**BZ001**

Knife Mounting Screws  
(4/pkg)  
**Stainless Steel**

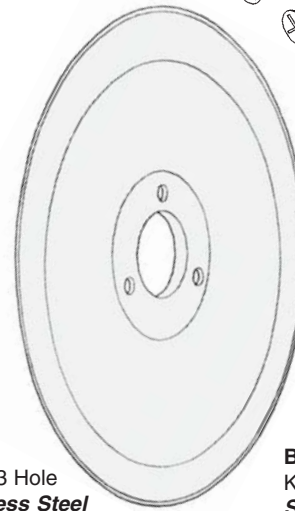
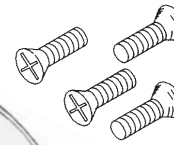

**BZK-3**  
Knife, 3 Hole  
**Stainless Steel**



**BZK-4**  
Knife, 4 Hole  
**Stainless Steel**

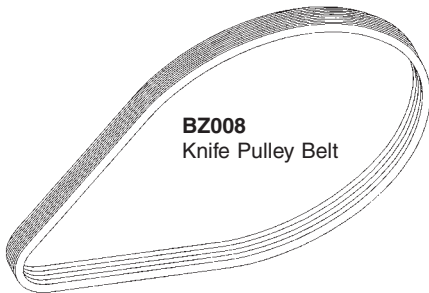

**BZ008**  
Knife Pulley Belt

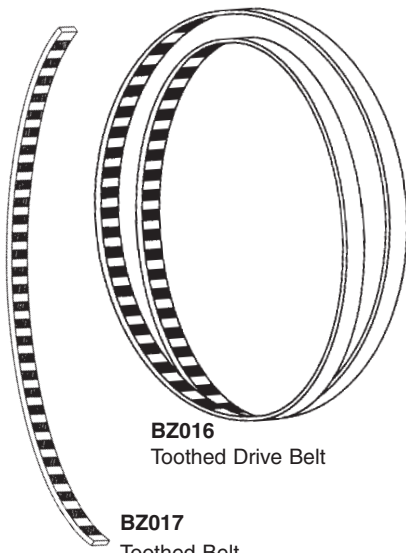

**BZ016**  
Toothed Drive Belt

**BZ017**  
Toothed Belt

**Don't let the exposed razor-sharp slicer knife become a hazard for the repairman and the slicer operator.**

**Use the KC1, KC2 or SC-02 safety covers to save FINGERS and \$\$\$\$\$.**

**KC1**  
Knife Safety Cover  
(Plastic) (NBS Lip design)  
11" & 12" Slicer Knives

**KC2**  
Knife Safety Cover  
(Plastic) (NBS Lip design)  
12 1/2" Slicer Knives

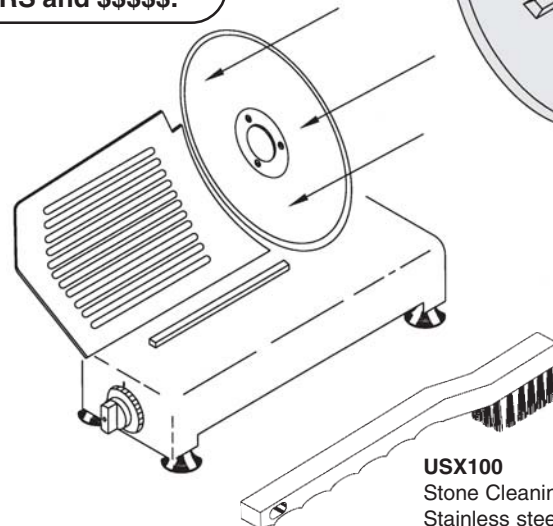
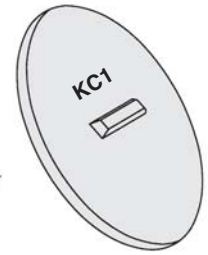

**USX100**  
Stone Cleaning Brush  
Stainless steel wire brush helps to clean grease clogged sharpening stones

**FITS MODELS**

NBS P/N	OEM P/N	DESCRIPTION	A330	A400	355	SE8	SE12	SG8D
BZ001	57451640000	Knife Mounting Screws (Stainless-Metric) (4/pkg)	X		X	X	X	X
BZ008	50009490000	Knife Pulley Belt				X		X
BZ016	40530300022	Toothed Drive Belt	X					
BZ017	40530300021	Toothed Belt	X					
BZ039	56448600000	Spindle Nuts, Truing - Grinding Stones - Left Hand	X			X		X
BZK-3	40220000700	Knife, 3 Hole				X		X
BZK-4	60530101500	Knife, 4 Hole	X	X			X	
BZST-1	40220601600	Sharpener Stones (sold as set only)	X			X		X
KC1	N/C	Knife Safety Cover	CAN BE USED ON MOST MANUFACTURERS SLICING MACHINES					
KC2	N/C	Knife Safety Cover						
USX100	N/A	Stone Cleaning Brush						

The above described parts are supplied by **National Band Saw Company** as replacement parts for **Bizerba** equipment.

